

*Registered / Registrato 30/06/2021*

*No 008595706-0001*



**EUROPEAN UNION INTELLECTUAL  
PROPERTY OFFICE  
CERTIFICATE OF REGISTRATION**

This Certificate of Registration is hereby issued for the Registered Community Design identified below. The corresponding entries have been recorded in the Register of Community Designs.

---

**UFFICIO DELL'UNIONE EUROPEA PER  
LA PROPRIETÀ INTELLETTUALE  
CERTIFICATO DI  
REGISTRAZIONE**

Il presente Certificato di Registrazione è emesso per il Disegno o Modello Comunitario registrato descritto di seguito. I dati corrispondenti sono stati iscritti nel Registro dei Disegni e Modelli Comunitari.

*The Executive Director / Il Direttore  
esecutivo*

*Christian Archambeau*





21	008595706-0001
25	EN - IT
22	30/06/2021
15	30/06/2021
45	12/07/2021
11	008595706-0001
72	Ronny Gobbo Ricardo Rodriguez
73	G.D. & C. S.r.l. Via O. Bottecchia 6 I-33087 Pasiano di Pordenone PN ITALIA
74	SOCIETÀ ITALIANA BREVETTI S.P.A. Stradone San Fermo, 21/B I-37121 Verona ITALIA
51	06 - 03
54	<b>BG</b> - Офис маси, бюра
	<b>ES</b> - Mesas de oficina
	<b>CS</b> - Psací stoly
	<b>DA</b> - Borde til kontorbrug
	<b>DE</b> - Bürotische
	<b>ET</b> - Kontorilauad
	<b>EL</b> - Τραπεζία γραφείου
	<b>EN</b> - Office tables
	<b>FR</b> - Tables de bureau
	<b>IT</b> - Scrivanie da ufficio
	<b>LV</b> - Biroja galdi
	<b>LT</b> - Biuro stalai
	<b>HR</b> - Uredski stolovi
	<b>HU</b> - Írodai asztalok
	<b>MT</b> - Mwejjed tal-uffiċċju
	<b>NL</b> - Bureaus voor kantoren
	<b>PL</b> - Stoły biurowe
	<b>PT</b> - Mesas de escritório
	<b>RO</b> - Mese de birou
	<b>SK</b> - Kancelárske stoly
	<b>SL</b> - Pisalne mize
	<b>FI</b> - Toimistopöydät
	<b>SV</b> - Kontorsbord
30	-
55	-

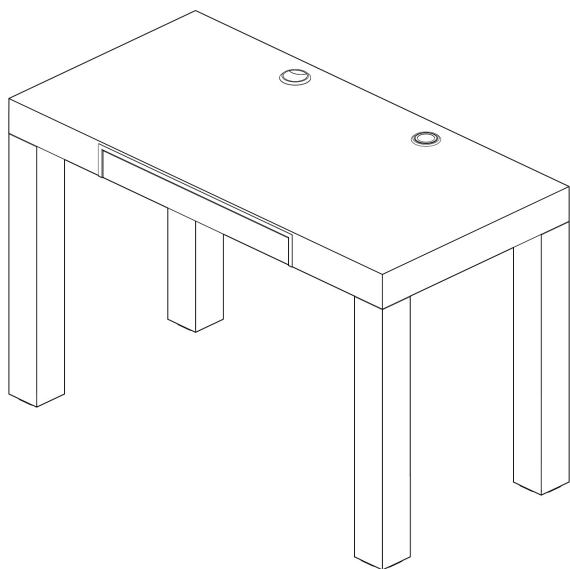

0001.1

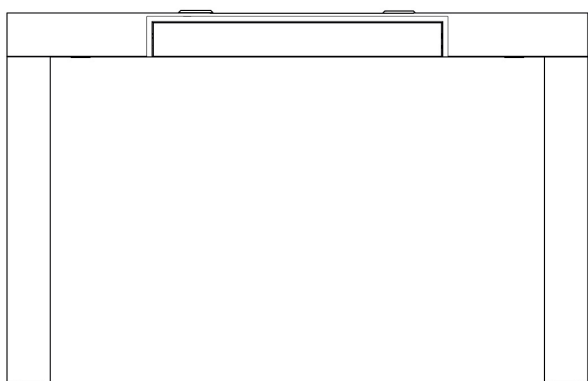

0001.2

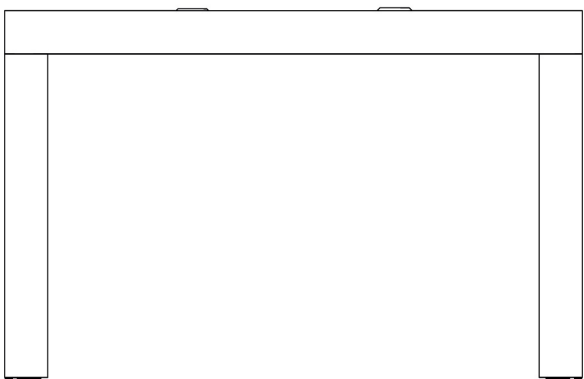

0001.3

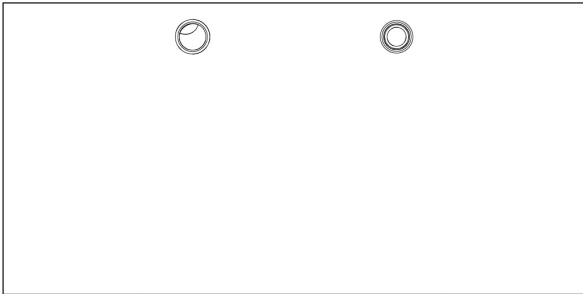

0001.4

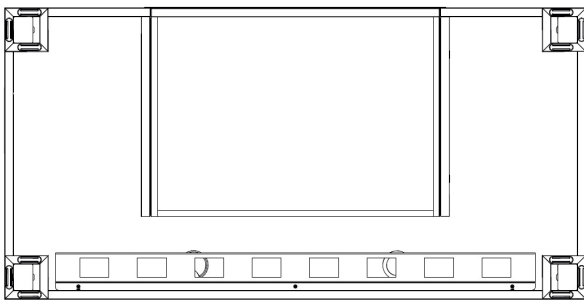

0001.5

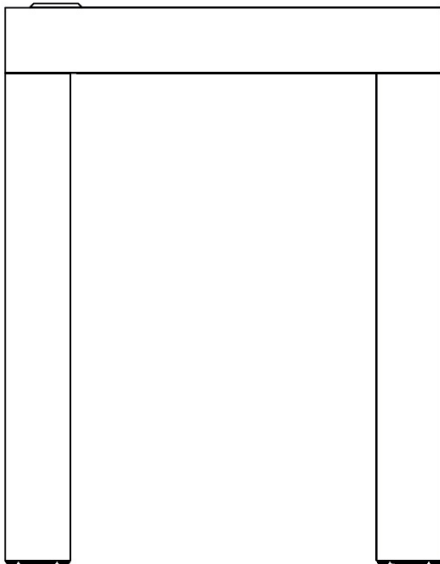

0001.6

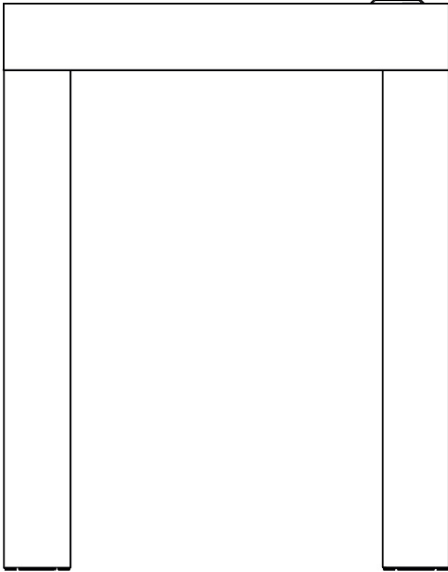

0001.7